

Pull handles



more than usual **duraplus**[®]

M545LG/23

HOPPE brass light curved pull handle on rose, **Cannes Series**. Concealed fixing: **including fixing system**. Design by Giugiaro Design.



Article description	Pull handle Ø	Distance	F41-R	F49-R	F71	F72	P.U.	O.C.
			Article no.	Article no.	Article no.	Article no.		
Pull handle with concealed fixing system, piece	dependent on form	220	2664134	2664142	2664118	2664126	1	5

Article description	Pull handle Ø	Distance	F73	F77-R			P.U.	O.C.
			Article no.	Article no.				
Pull handle with concealed fixing system, piece	dependent on form	220	2667116	2664151			1	5

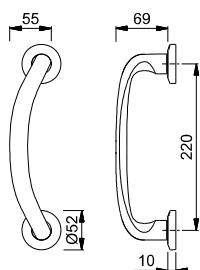

Included fixing systems for wooden doors:



The Resista® guarantee applies to all finishes with the letter R in the finish key.

Resista®
10 years' surface guarantee

M545LG

HOPPE brass light curved pull handle, **Cannes Series**. Concealed fixing: **including fixing system no. 11** (1 x BS-1101 and 1 x BS-1102). Design by Giugiaro Design.



Article description	Pull handle Ø	Distance	F41-R	F49-R	F71	F72	P.U.	O.C.
			Article no.	Article no.	Article no.	Article no.		
Pull handle with concealed fixing system, piece	dependent on form	220	2664089	2664097	2664062	2664071	1	5

Article description	Pull handle Ø	Distance	F73	F77-R			P.U.	O.C.
			Article no.	Article no.				
Pull handle with concealed fixing system, piece	dependent on form	220	2667108	2664100			1	5

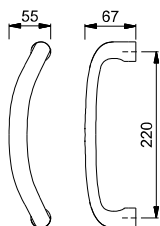

Included fixing systems:



BS-1101



BS-1102

The Resista® guarantee applies to all finishes with the letter R in the finish key.

Resista®
10 years' surface guarantee

Fixing systems for pull handles see on pages 272-274.

M439/42

HOPPE brass straight pull handle on rose, **Valencia Series**. Concealed fixing: **including fixing system**.



Article description	Distance	F41-R	F71	F73	F77-R	P.U.	O.C.
		Article no.	Article no.	Article no.	Article no.		
Pull handle with concealed fixing system, piece	194	684526	525744	716678	1876944	1	5

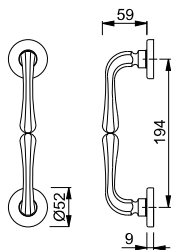

Included fixing systems for wooden doors:



The Resista® guarantee applies to all finishes with the letter R in the finish key.

Resista®
10 years' surface guarantee

M515LG/23

HOPPE brass light curved pull handle on rose, **Vitória Series**. Concealed fixing: **including fixing system**.



Article description	Pull handle Ø	Distance	F41-R	F49-R	F71	F72	P.U.	O.C.
			Article no.	Article no.	Article no.	Article no.		
Pull handle with concealed fixing system, piece	dependent on form	210	2844830	2844821	2844784	2844805	1	5

Article description	Pull handle Ø	Distance	F73	F77-R			P.U.	O.C.
			Article no.	Article no.				
Pull handle with concealed fixing system, piece	dependent on form	210	2844813	2844848			1	5

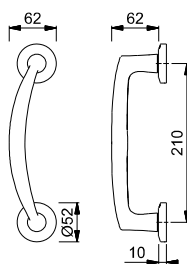

Included fixing systems for wooden doors:



The Resista® guarantee applies to all finishes with the letter R in the finish key.

Resista®
10 years' surface guarantee

Pull handles (Aluminium)

5010

HOPPE aluminium straight pull handle for entrance doors, **including fixing system no. 11** (2 x BS-1102).



Article description	Pull handle Ø	Distance	F1-2			P.U.	O.C.
			Article no.				
Pull handle straight 5010, piece	30	300	609253			1	5
		350	655908			1	5

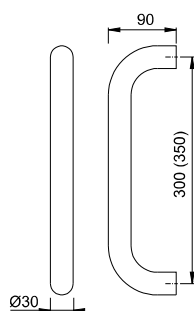

Included fixing systems:



BS-1102

Fixing systems for pull handles
see on pages 272-274.

5004

HOPPE aluminium straight pull handle with angular (45°) square supports for entrance doors, **including fixing system no. 11** (1 x BS-1101 and 1 x BS-1102).



Article description	Pull handle Ø	Distance	F1-2	F9-2	P.U.	O.C.
			Article no.	Article no.		
Pull handle 5004, piece	25	330/210	2345942	2345951	1	5

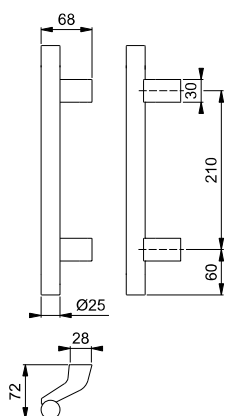

Included fixing systems:



BS-1101



BS-1102

Fixing systems for pull handles
see on pages 272-274.

5004D with design-rings

HOPPE aluminium straight pull handle with design-rings: with angular (45°) square supports, for entrance doors, **including fixing system no. 11** (1 x BS-1101 and 1 x BS-1102).



Beschreibung	Pull handle Ø	Distance	F1-2	F9-2			P.U.	O.C.
			Article no.	Article no.				
Pull handle 5004D with design-rings, piece	25	330/210	2346179	2346195			1	5

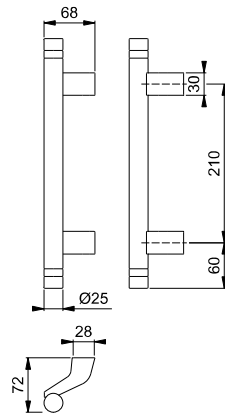

Included fixing systems:



BS-1101



BS-1102

Fixing systems for pull handles see on pages 272-274.

5040

HOPPE aluminium straight pull handle for entrance doors, for fixing system M8.



Article description	Pull handle Ø	Distance	F1	F9			P.U.	O.C.
			Article no.	Article no.				
Pull handle straight 5040 inside, piece	20	220	605477	605484			1	5
Pull handle straight 5040 outside, piece			678013	693900			1	5

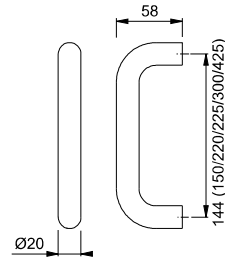

Fixing systems for pull handles see on pages 272-274.

Pull handles (Aluminium)

5210

HOPPE aluminium triangular pull handle for entrance doors, **including fixing system no. 11** (2 x BS-1102).



Article description	Pull handle Ø	Distance	F1-2				P.U.	O.C.
			Article no.					
Pull handle triangular 5210, piece	30	300	655946			1	5	
		350	606269			1	5	

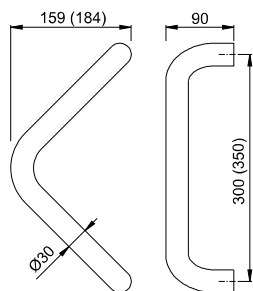

Included fixing systems:



BS-1102

Fixing systems for pull handles
see on pages 272-274.

5310

HOPPE aluminium semi-circular pull handle for entrance doors, **including fixing system no. 11** (2 x BS-1102).



Article description	Pull handle Ø	Distance	F1-2				P.U.	O.C.
			Article no.					
Pull handle semi-circular 5310, piece	30	300	807215			1	5	
		350	655953			1	5	

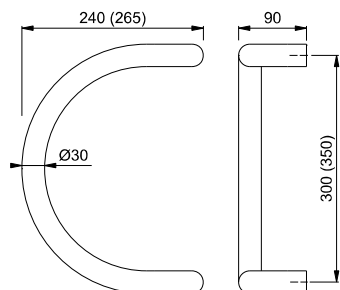

Included fixing systems:



BS-1102

Fixing systems for pull handles
see on pages 272-274.

5710

HOPPE aluminium straight pull handle for entrance doors, **including fixing system no. 11** (2 x BS-1102).



Article description	Pull handle Ø	Distance	F1-2	F9-2			P.U.	O.C.
			Article no.	Article no.				
Pull handle straight 5710, piece	dependent on form	300	2550882	2550891			1	5

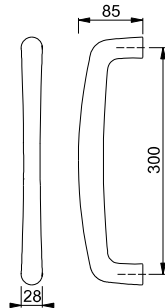

Included fixing systems:



BS-1102

Fixing systems for pull handles
see on pages 272-274.

E5000 – E5010

HOPPE stainless steel straight pull handle for entrance doors, **including fixing system no. 11** (2 x BS-1102).



Article description	Pull handle Ø	Distance	F69	F77-R			P.U.	O.C.
			Article no.	Article no.				
Pull handle straight E5000, piece	25	300	553648	832965			1	5
		350	602551	1693048			1	5
Pull handle straight E5010, piece	30	300	556144				1	5
		350	602599				1	5

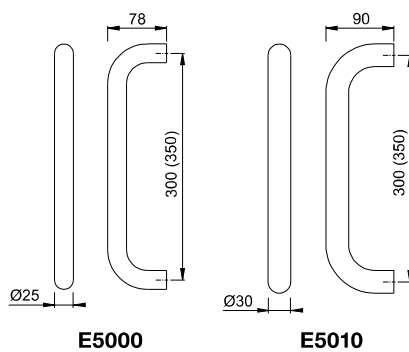

The Resista® guarantee applies to
all finishes with the letter R in the
finish key.

Resista®
10 years' surface
guarantee

Included fixing systems:



BS-1102

Fixing systems for pull handles
see on page 266.

Pull handles (Stainless steel)

E5011

HOPPE stainless steel straight pull handle for entrance doors, **including fixing system no. 11** (2 x BS-1102).



Article description	Pull handle Ø	Distance	F69				P.U.	O.C.
			Article no.					
Pull handle straight 5011, piece	27/30	400/300	6520605				1	5
		500/300	2010595				1	5
		600/400	2010624				1	5
		800/560	2010632				1	5
		1000/700	2010659				1	5
		1200/900	2010974				1	5
		1400/1000	2010982				1	5
		1600/1200	2011029				1	5
		1800/1300	2011037				1	5

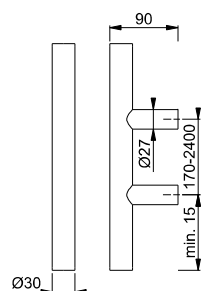

Special lengths on request. Surcharge for special lengths per started 100 mm. **When ordering pull handles of special lengths please indicate exact lengths of handle required and the distance! (necessary for the positioning of the supports).**

Also available with several supports.

Included fixing systems:



BS-1102

Fixing systems for pull handles see on pages 272-274.

E5012

HOPPE stainless steel straight pull handle with angular (45°) supports, for entrance doors, **including fixing system no. 11** (2 x BS-1102).



Article description	Pull handle Ø	Distance	F69				P.U.	O.C.
			Article no.					
Pull handle straight 5012, piece	27/30	400/300	8124414				1	5
		500/300	2011053				1	5
		600/400	2011061				1	5
		800/560	2011555				1	5
		1000/700	2011571				1	5
		1200/900	2011598				1	5
		1400/1000	2011643				1	5
		1600/1200	2011678				1	5
		1800/1300	2011707				1	5

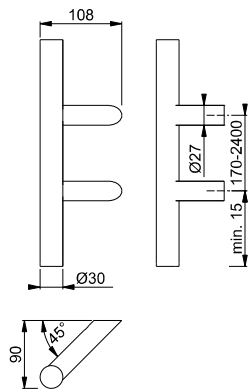

Special lengths on request, Surcharge for special lengths per started 100 mm. **When ordering pull handles of special lengths please indicate exact lengths of handle required and the distance! (necessary for the positioning of the supports).**

Also available with several supports.

Included fixing systems:



BS-1102

Fixing systems for pull handles see on pages 272-274.

Pull handles (Stainless steel)

E5014

HOPPE stainless steel straight pull handle with angular (45°), square supports of **aluminium**, for entrance doors; **including fixing system no. 11** (1 x BS-1101 and 1 x BS-1102 if distance 250 mm, 2 x BS-1102 if distance 300 mm or 400 mm).

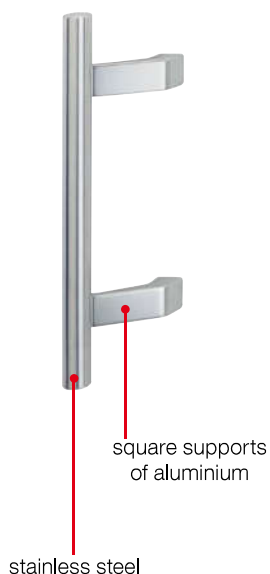

Article description	Pull handle Ø	Distance	F69/F1				P.U.	O.C.
			Article no.					
Pull handle straight 5014, piece	30	400/250	2206301				1	5
		500/300	2206344				1	5
		600/400	2206387				1	5

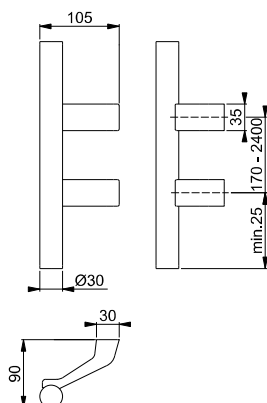

Special lengths on request. Surcharge for special lengths per started 100 mm. **When ordering pull handles of special lengths please indicate exact lengths of handle required and the distance! (necessary for the positioning of the supports).**

Also available with several supports.

Included fixing systems:

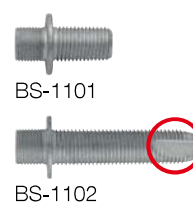

Fixing systems for pull handles see on pages 272-274.

E5015

HOPPE stainless steel straight pull handle for entrance doors, **including fixing system no. 11** (2 x BS-1102).



Article description	Pull handle Ø	Distance	F69				P.U.	O.C.
			Article no.					
Pull handle straight 5015, piece	30	300	2206766				1	5
		350	2206782				1	5

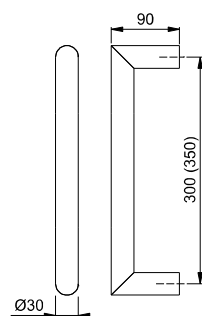

Special lengths on request. Surcharge for special lengths per started 100 mm. **When ordering pull handles of special lengths please indicate exact lengths of handle required and the distance! (necessary for the positioning of the supports).**

Also available with several supports.

Included fixing systems:

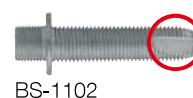

Fixing systems for pull handles see on pages 272-274.

E5100 – E5110

HOPPE stainless steel cranked pull handle for entrance doors, **including fixing system no. 11** (2 x BS-1102).



Beschreibung	Pull handle Ø	Distance	F69			P.U.	O.C.
			Article no.				
Pull handle, cranked, E5100, piece	25	300	602575			1	5
		350	556090			1	5
Pull handle, cranked, E5110, piece	30	300	602605			1	5
		350	610563			1	5

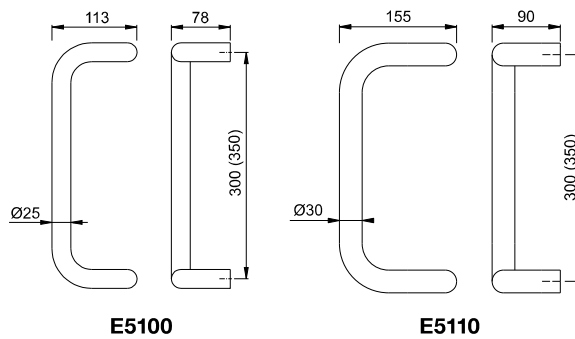

E5100

E5110

Included fixing systems:



BS-1102

Fixing systems for pull handles
see on pages 272-274.

Pull handles (Stainless steel)

E5210

HOPPE stainless steel triangular pull handle for entrance doors, **including fixing system no. 11** (2 x BS-1102).



Article description	Pull handle Ø	Distance	F69				P.U.	O.C.
			Article no.					
Pull handle triangular E5210, piece	30	300	556106			1	5	
		350	595297			1	5	

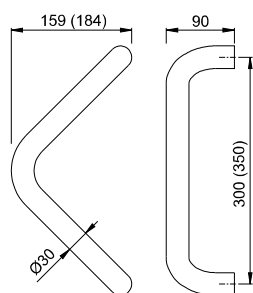

Included fixing systems:



BS-1102

Fixing systems for pull handles
see on pages 272-274.

E5215

HOPPE stainless steel triangular pull handle for entrance doors, **including fixing system no. 11** (2 x BS-1102).



Article description	Pull handle Ø	Distance	F69				P.U.	O.C.
			Article no.					
Pull handle triangular E5215, piece	30	300	2206811			1	5	
		350	2206838			1	5	

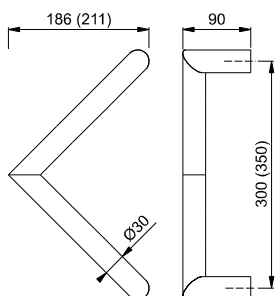

Included fixing systems:



BS-1102

Fixing systems for pull handles
see on pages 272-274.

E5310

HOPPE stainless steel semi-circular pull handle for entrance doors, **including fixing system no. 11** (2 x BS-1102).



Article description	Pull handle Ø	Distance	F69				P.U.	O.C.
			Article no.					
Pull handle semi-circular E5310, piece	30	300	6804538				1	5
		350	598212				1	5

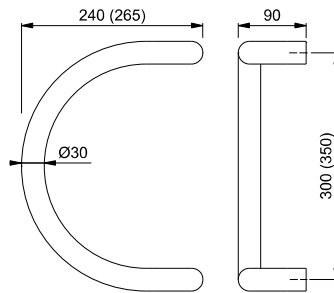

Included fixing systems:



BS-1102

Fixing systems for pull handles
see on pages 272-274.

E5311

HOPPE stainless steel semi-circular pull handle for entrance doors: with straight supports, **including fixing system no. 11** (2 x BS-1102).



Article description	Pull handle Ø	Distance	F69				P.U.	O.C.
			Article no.					
Pull handle semi-circular E5311, piece	27/30	300	588282				1	5
		350	610617				1	5

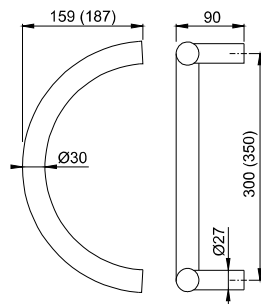

Included fixing systems:



BS-1102

Fixing systems for pull handles
see on pages 272-274.

Pull handles (Stainless steel)

E5511

HOPPE stainless steel light curved pull handle for entrance doors: with straight supports, **including fixing system no. 11** (2 x BS-1102).



Article description	Pull handle Ø	Distance	F69				P.U.	O.C.
			Article no.					
Pull handle light curved, E5511, piece	27/30	800/695	2611059				1	5
		1200/1000	2694851				1	5
		1600/1400	2694860				1	5
		2000/1800	2694878				1	5

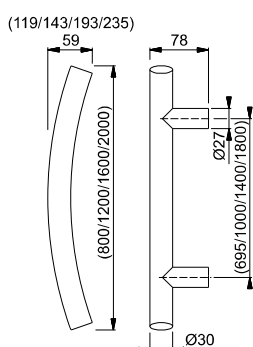

Included fixing systems:



BS-1102

Fixing systems for pull handles see on pages 272-274.

E5600

HOPPE stainless steel, flat bow-shaped pull handle for entrance doors.



Article description	Distance	F69				P.U.	O.C.
		Article no.					
Pull handle flat bow-shaped E5600, piece	390/350	2206862				1	5

Can be used for concealed fixing with two screws M8 (not included) on aluminium and nylon doors.

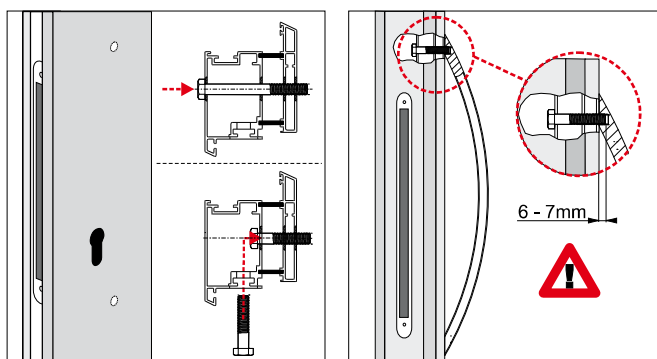
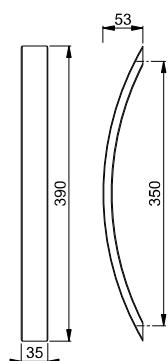

Fixing systems for pull handles see on pages 272-274.

E5606

HOPPE stainless steel, flat bow-shaped pull handle with square, straight supports for entrance doors: **including fixing system no. 11** (1 x BS-1101 and 1 x BS-1102 if distance 250 mm, 2 x BS-1102 if distance 350 mm or 500 mm).



Article description	Distance	F69				P.U.	O.C.
		Article no.					
Pull handle flat bow-shaped E5606, piece	408/250	2206871				1	5
	500/350	2420375				1	5
	697/500	2292473				1	5

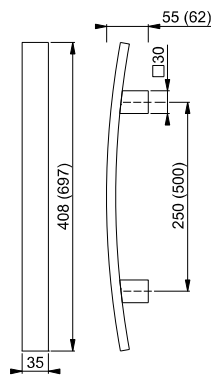

Included fixing systems:



BS-1101



BS-1102

Fixing systems for pull handles see on pages 272-274.

M553

HOPPE brass triangular curved pull handle for entrance doors, **including fixing system no. 11** (1 x BS-1101 and 1 x BS-1102).



Article description	Pull handle Ø	Distance	F41-R	F73	F77-R	P.U.	O.C.
			Article no.	Article no.	Article no.		
Pull handle triangular curved M553, piece	dependent on form	250	1885015	1843860	1886288	1	5

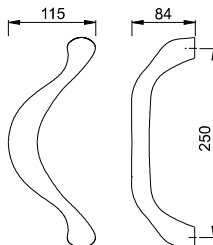

The Resista® guarantee applies to all finishes with the letter R in the finish key.

Resista®
10 years' surface guarantee

Included fixing systems:



BS-1101



BS-1102

Fixing systems for pull handles see on pages 272-274.

