

Touch 445



ASSA ABLOY

ASSA ABLOY, the global leader
in door opening solutions



Touch 445

Maniglione antipanico da applicare Touch (Tipo B)

Caratteristiche:

- Reversibile
- Modulare (per 1, 2 o 3 punti di chiusura)
- Adatto per porte ad anta singola o doppia
- Idoneo per porte tagliafuoco/antifumo
- Barra orizzontale in alluminio
- Testata e slitta in acciaio verniciato nero
- Contropiastra in acciaio
- 4 spessori per contropiastra in plastica inclusi
- 1 tappo in nylon incluso per la copertura dello scrocco centrale (per applicazioni a due punti di chiusura)
- 1 tappo in nylon incluso per la chiusura del foro di passaggio delle aste per scrocci alto/basso (per applicazioni monopunto)
- Confezione in scatola
- Versione con fermo a giorno disponibile
- Versione con microswitch disponibile

Versionsi:

- Standard reversibile
- Con fermo a giorno: Dx o Sx
- Con micro-switch: Dx o Sx

Da ordinare a parte:

- Kit scrocci Alto/Basso con contropiastre
- Kit aste verticali con copriaste
- Maniglia esterna
- Cilindro esterno

Il Maniglione da applicare Touch 445 è idoneo per il montaggio su ante principali e secondarie di porte in acciaio, alluminio o legno.

Touch rim panic exit device (Type B)

Features:

- Reversible
- Modular (for 1, 2 or 3 locking points)
- Suitable for single or double leaf doors
- Certified for fire rated doors
- Aluminum horizontal bar
- Black painted steel head cover and chassis
- Strike plate in steel
- 4 thicknesses in plastic for strike plate included
- 1 nylon cap for covering the central latch included (for 2 locking points solutions)
- 1 nylon cap for closing the hole for upper/lower latch included (for 1 locking point solutions)
- Packaging in box
- Version with hold open device available
- Version with microswitch available

Versions:

- Reversible standard
- With hold open device: Right or Left
- With micro-switch: Right or Left

To be ordered separately:

- Upper/lower latches kit with strike plates
- Vertical rods kit with covers
- External handle
- External cylinder

Touch 445 rim panic exit device can be mounted both on the active and inactive leaf of steel, aluminium or wooden doors.



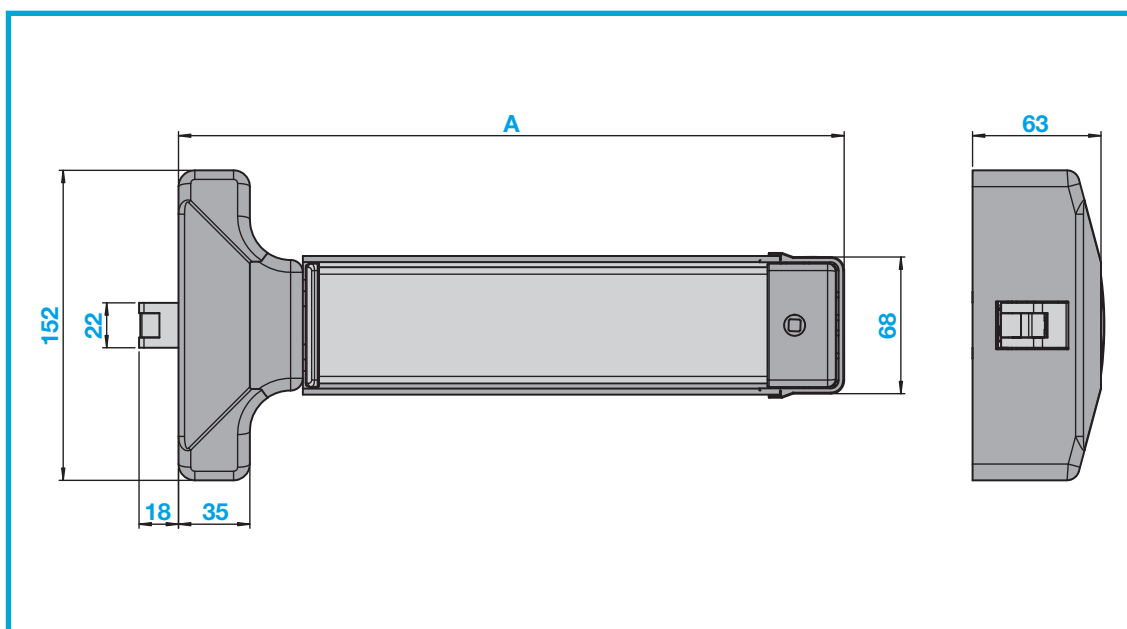

Maniglione antipánico
TOUCH 445
TOUCH 445 panic
exit device

Codice / Code	A mm	Finitura Finish	Regolazione Adjustment mm		
44505 32 000	320	Rosso / Red	-	2260	1
44505 64 000	640	Rosso / Red	500÷650	3380	1
44505 84 000	840	Rosso / Red	650÷850	3700	1
44505 11 000	1140	Rosso / Red	850÷1150	5000	1
44505 13 000	1300	Rosso / Red	850÷1310	6000	1

Maniglione antipánico
TOUCH 445 con
microswitch
TOUCH 445 panic exit
device with microswitch

44505 64 000 MIC	640	Rosso / Red	500÷650	3380	1
44505 84 000 MIC	840	Rosso / Red	650÷850	3700	1
44505 11 000 MIC	1140	Rosso / Red	850÷1150	5000	1
44505 13 000 MIC	1300	Rosso / Red	850÷1310	6000	1

Per le finiture su richiesta aggiungere ai codici indicati sopra: / For the finishes upon request add at the end of the above codes:

N = Nero / Black

V = Verde / Green

AUK = Argento / Silver

Barre (Ricambio) Horizontal bars (Spare Part)

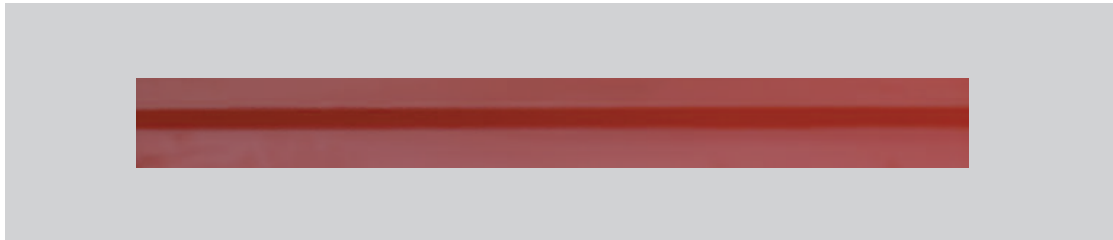

Codice / Code	Finitura / Finish	Regolazione Adjustment mm	 gr	
04441 84 000	Rosso / Red	700÷900	650	1
04441 11 000	Rosso / Red	900÷1200	700	1
04441 13 000	Rosso / Red	1300	900	1

Per le finiture su richiesta aggiungere ai codici indicati sopra: / For the finishes upon request add at the end of the above codes:

N = Nero / Black	V = Verde / Green	AUK = Argento / Silver
------------------	-------------------	------------------------

Chiusura laterale Lateral Locking



Per ottenere la versione monopunto, il maniglione antipanico è fornito con tappi in nylon per la chiusura dei fori di passaggio delle aste verticali

To get the single point solution, the panic exit device is provided with a nylon cover plug to close the holes for vertical rods

Chiusura duplice Double locking

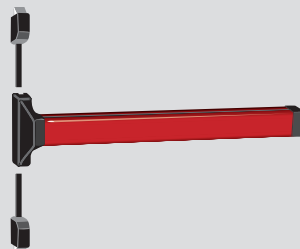

Aggiungendo i Kit 0342900 (Kit scrocchi) e 04444 (Kit aste), e rendendo inoperante lo scrocco centrale per mezzo di un tappo copriforo in nylon, si ottiene la soluzione a due punti di chiusura

By adding the 0342900 (Latches Kit) and 04444 (Rods Kit) kits, and rendering the lateral latch inoperative by means of the nylon cover plug, it's possible to get the 2 locking points solution

Chiusura tripla Three locking points

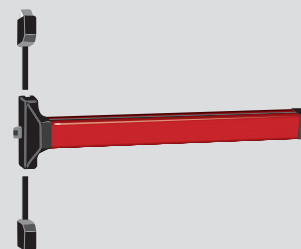

Aggiungendo i Kit 0342900 (Kit scrocchi) e 04444 (Kit aste), si ottiene la soluzione a 3 punti di chiusura

By adding the 0342900 (Latches Kit) and 04444 (Rods Kit) kits, it's possible to get the 3 locking points solution

Accessori per Touch 445

Accessories for Touch 445



Kit scrochi con contropiastre
Latches with strike plates kit

Codice / Code	Mano / Hand		
03429 00 000	-	1.000	1

Kit Scrochi Alto/Basso Verticali
Vertical Upper/Lower Latches Kit



Codice / Code	Mano / Hand		
03429 00 050	-	1.000	1

Kit Scrochi laterali
Lateral Upper/Lower Latches Kit



Codice / Code	H (mm) porte/doors	L (mm) aste superiori / upper rods		
04444 00 000	2.200	1.162	1.150	1
04444 01 000	2.400	1.362	1.310	1
04444 02 000	2.600	1.562	1.400	1
04444 03 000	2.800	1.762	1.490	1
04444 04 000	3.000	1.962	1.690	1

Kit aste verticali con copriaste
Vertical rods with cover Kit



Kit rosetta e mezzo cilindro
Single cylinder with escutcheon kit

Codice / Code	Finitura Finish	Spess. porte Door thickness		
80 (70-10) mm				
04440 05 000	Nichelato / Nickel plated	max 50 mm	190	1
90 (80-10) mm				
04440 06 000	Nichelato / Nickel plated	max 60 mm	190	1



Codice / Code	Finitura / Finish		
04480 08 000	Nero / Black	500	1
Con Microswitch / With Microswitch			
04480 08 000MIC	Nero / Black	500	1

Maniglia universale "Jolly" con cilindro profilato intercambiabile con altri cilindri di sicurezza
Universal handle Kit "Jolly" with profile cylinder interchangeable with other security cylinders

Accessori per Touch 445

Accessories for Touch 445



Kit controplacca maniglia e cilindro
Lever handle on plate with cylinder

Codice / Code	Finitura Finish	Spessore Porta Door thickness mm	gr.	
---------------	-----------------	----------------------------------	-----	--

Controplacca con maniglia e cilindro 70-10
Lever Handle on plate with cylinder 70-10

04440 01 000	Nero / black	50	645	1
---------------------	--------------	----	-----	---

Controplacca con maniglia e cilindro 80-10
Lever Handle on plate with cylinder 80-10

04440 04 000	Nero / black	60	675	1
---------------------	--------------	----	-----	---

Controplacca cieca con maniglia
Lever handle on closed plate

04440 02 000	Nero / black	-	400	1
---------------------	--------------	---	-----	---

Controplacca con foro cilindro e maniglia (cilindro non incluso)
Lever handle on plate with cylinder hole (cylinder not included)

04440 00 000	Nero / black	-	400	1
---------------------	--------------	---	-----	---



Codice / Code



Contropiastra per scrocco centrale completa di 4 spessori (Ricambio)
Strike plate for central latch including 4 thicknesses (Spare Part)

02400 01 000	50	1
---------------------	----	---



Codice / Code



Contropiastra a pavimento (Ricambio)
Floor strike plate (Spare Part)

02400 02 000	70	10
---------------------	----	----



Codice / Code



Contropiastra laterale e superiore completa di 4 spessori (Ricambio)
Lateral or upper strike plate including 4 thicknesses (Spare Part)

02400 03 000	40	10
---------------------	----	----

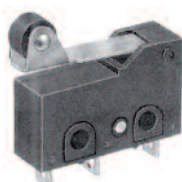

Codice / Code



Coppia di microinterruttori
Pair of microswitches

04400 00 000	20	1
---------------------	----	---

Schemi di applicazione Applications patterns

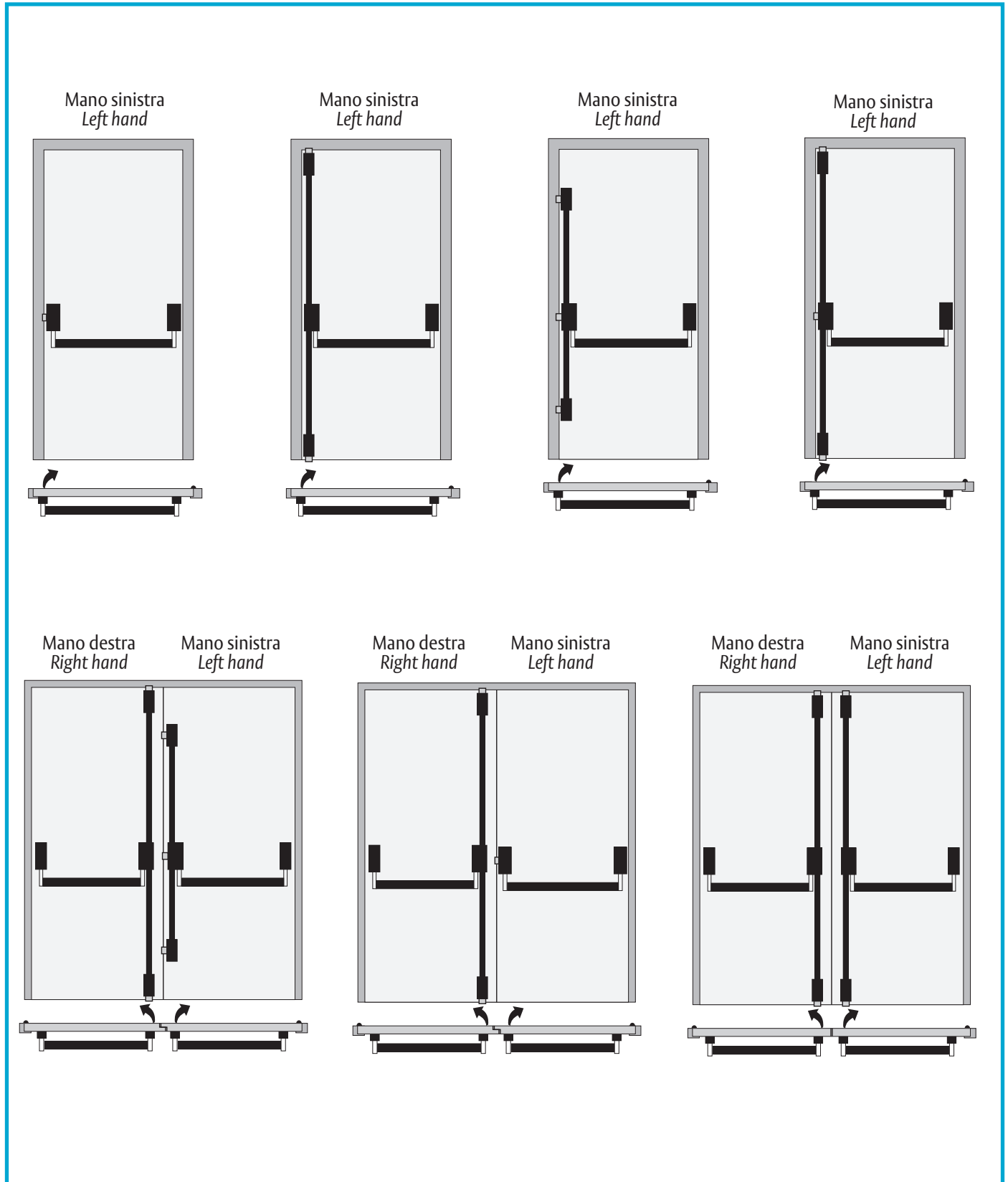

Configurazioni per Porte ad Anta Singola

Compositions for Single Leaf Doors

X = Necessari / Necessary
 □ = Facoltativi / Optional
 ● = Alternativi / Alternative

xxx = Finiture e/o varianti (vedere listino)
 Finishes and/or variants (see price list)

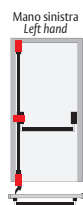
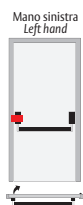

	Centrale Central	44505xxx	X	X	X	X	X	Anta Primaria / Primary Leaf
	A/B Verticali Upper/Lower Vertical	0342900000xxx	-	X	X	-	-	
	A/B Lateral Upper/Lower Lateral	0342900050xxx	-	-	-	X	X	
	Kit Aste Verticali con Copriaste/Vertical Rods Kit with Covers	04444xxx	-	X	X	X	X	
	Kit Maniglia Esterna External Handle Kit	0448008xxx	□ ●	□ ●	□ ●	□ ●	□ ●	
	Cilindro singolo Single Cylinder	04440xxx	□ ●	□ ●	□ ●	□ ●	□ ●	
	Kit controplacca Lever Handle on Plate Kit	04440xxx	□ ●	□ ●	□ ●	□ ●	□ ●	
	Centrale Central	44505xxx	-	-	-	-	-	Anta Secondaria/Secondary Leaf
	A/B Verticali Upper/Lower Vertical	0342900000xxx	-	-	-	-	-	
	Kit Aste Verticali con Copriaste/Vertical Rods Kit with Covers	04444xxx	-	-	-	-	-	

Configurazioni per Porte ad Anta Doppia

Compositions for Double Leaf Doors

- X = Necessari / Necessary
- = Facoltativi / Optional
- = Alternativi / Alternative

xxx = Finiture e/o varianti (vedere listino)
Finishes and/or variants (see price list)

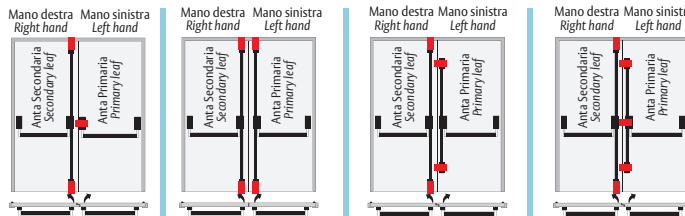

			Mano destra / Right hand	Mano sinistra / Left hand	Mano destra / Right hand	Mano sinistra / Left hand	Mano destra / Right hand	Mano sinistra / Left hand	
	Centrale / Central	44505xxx	X	X	X	X	X	X	Anta Primaria / Primary Leaf
	A/B Verticali / Upper/Lower Vertical	0342900000xxx	-	X	-	-	-	-	
	A/B Lateral / Upper/Lower Lateral	0342900050xxx	-	-	X	X	X	X	
	Kit Aste Verticali con Copriaste / Vertical Rods Kit with Covers	04444xxx	-	X	X	X	X	X	
	Kit Maniglia Esterna / External Handle Kit	0448008xxx	□ ●	□ ●	□ ●	□ ●	□ ●	□ ●	
	Cilindro singolo / Single Cylinder	04440xxx	□ ●	□ ●	□ ●	□ ●	□ ●	□ ●	
	Kit controplacca / Lever Handle on Plate Kit	04440xxx	□ ●	□ ●	□ ●	□ ●	□ ●	□ ●	
	Centrale / Central	44505xxx	X	X	X	X	X	X	Anta Secondaria / Secondary Leaf
	A/B Verticali / Upper/Lower Vertical	0342900000xxx	X	X	X	X	X	X	
	Kit Aste Verticali con Copriaste / Vertical Rods Kit with Covers	04444xxx	X	X	X	X	X	X	



ASSA ABLOY Italia S.p.A.
Via Bovaresa 13 - 40017 San Giovanni in Persiceto (BO) Italy
Tel. +39 051 6812411 - Fax +39 051 827486
info@assaabloy.it - www.assaabloy.it

ASSA ABLOY is the global leader in door opening solutions, dedicated to satisfying end-user needs for security, safety and convenience.

www.assaabloy.com



ASSA ABLOY Italia S.p.A. si riserva di apportare in qualunque momento e senza preavviso le modifiche necessarie per migliorare ed evolvere le caratteristiche dei propri prodotti. Fotografie, illustrazioni e descrizioni sono da ritenersi indicative.
ASSA ABLOY Italia S.p.A. reserves the right at any time and without notice, the necessary modifications in order to improve and evolve the characteristics of their products. Photographs, illustrations and descriptions ought to be considered as indicative.

H001D03 / 02 - 2014